

HFD41/D41A

SUBMINIATURE SIGNAL RELAY



File No.:E170653



File No.:40000155

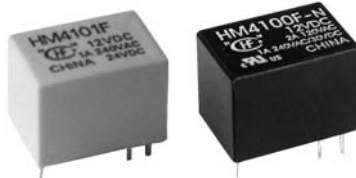

Features

- Extremely low cost
- 2A switching capability
- 1 Form C configuration
- Standard PCB layout
- Wash tight and flux proofed types available
- Environmental friendly product (RoHS compliant)
- Outline Dimensions: (15.7 x 11.0 x 12.0) mm

CONTACT DATA

Concat arrangement	1C
Contact resistance	100mΩ (at 1A 24VDC)
Contact material	AgNi
Contact rating (Res. load)	1A 125VAC/30VDC 1A 240VAC/30VDC 2A 125VAC, 3A 125VAC
Max. switching voltage	240VAC / 30VDC
Max. switching current	3A
Max. switching power	240VA / 30W
Mechanical endurance	1 x 10 ⁷ ops
Electrical endurance	1 x 10 ⁵ ops

CHARACTERISTICS

Insulation resistance	100MΩ (at 500VDC)	
Dielectric strength	Between coil & contacts	1000VAC 1min
	Between open contacts	500VAC 1min
Operate time (at nomi. volt.)	10ms max.	
Release time (at nomi. volt.)	5ms max.	
Shock resistance	Functional	98m/s ²
	Destructive	980m/s ²
Vibration resistance	10Hz to 55Hz 1.5mm DA	
Humidity	35% to 85% RH	
Ambient temperature	-25°C to 70°C	
Termination	PCB (DIP)	
Unit weight	Approx. 5g	
Construction	Wash tight, Flux proofed	

Notes: 1) The data shown above are initial values.
2) Please find coil temperature curve in the characteristic curves below.

COIL

Coil power B: 450mW; N: 360mW; H:200mW

COIL DATA

at 23°C

Nominal Voltage VDC	Pick-up Voltage VDC	Drop-out Voltage VDC	Max. Allowable Voltage VDC	Coil Resistance x (1±10%) Ω		
				H	N	B
3	2.3	0.3	3.9	45	25	20
5	3.8	0.5	6.5	120	70	56
6	4.5	0.6	7.8	180	100	80
9	6.8	0.9	11.7	400	220	180
12	9.0	1.2	15.6	700	400	320
24	18.0	2.4	31.2	2800	1600	1280

SAFETY APPROVAL RATINGS

UL&CUL	1A 125VAC/30VDC 1A 240VAC/30VDC 2A 125VAC
	1A 30VDC 1A 250VAC COSØ =1 2A 125VAC COSØ =1

Notes: Only some typical ratings are listed above. If more details are required, please contact us.



HONGFA RELAY

ISO9001, ISO/TS16949, ISO14001, OHSAS18001, IECQ QC 080000 CERTIFIED

2008 Rev. 1.00

ORDERING INFORMATION

Type	HFD41 HFD41A	-012	-N	S	(XXX)
Coil voltage	3, 5, 6, 9, 12, 24 VDC				
Coil power	B: 450mW	N: 360mW	H: 200mW		
Construction	S: Wash tight Nil: Flux proofed				
Customer special code					

OUTLINE DIMENSIONS, WIRING DIAGRAM AND PC BOARD LAYOUT

Unit: mm

Outline Dimensions

HFD41

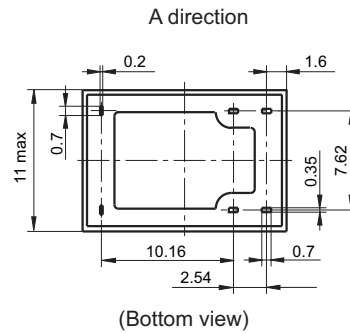
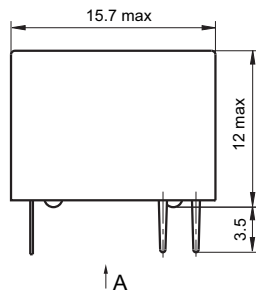

Wiring Diagram
(Bottom view)

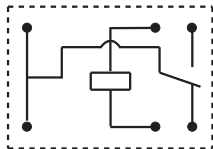

PCB Layout
(Bottom view)

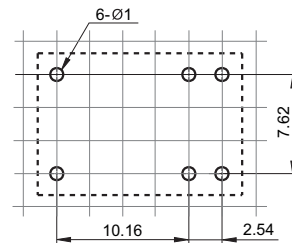

HFD41A

Outline Dimensions

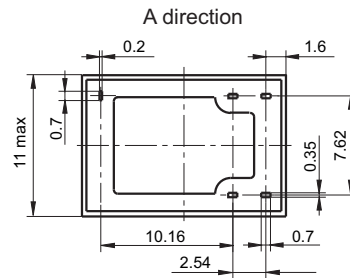
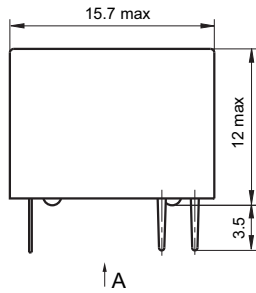

(Bottom view)

**Wiring Diagram
(Bottom view)**

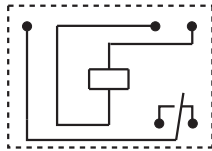

**PCB Layout
(Bottom view)**

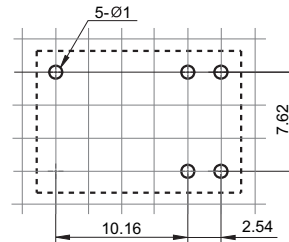

- Remark: 1) In case of no tolerance shown in outline dimension: outline dimension ≤ 1 mm, tolerance should be ± 0.2 mm; outline dimension > 1 mm and ≤ 5 mm, tolerance should be ± 0.3 mm; outline dimension > 5 mm, tolerance should be ± 0.4 mm.
 2) The tolerance without indicating for PCB layout is always ± 0.1 mm.
 3) The width of the gridding is 2.54mm.

CHARACTERISTIC CURVES

COIL TEMPERATURE RISE

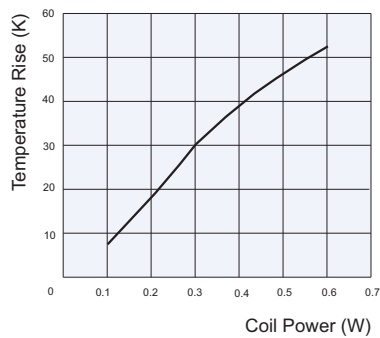

OPERATE TIME

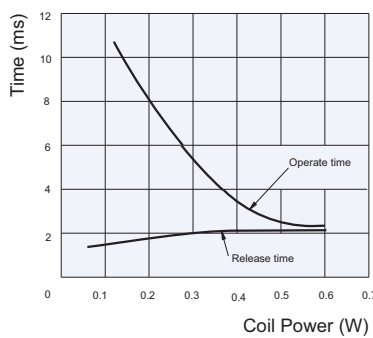

ENDURANCE CURVE

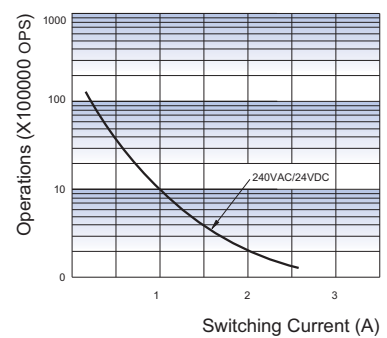

Disclaimer

This datasheet is for the customers' reference. All the specifications are subject to change without notice. We could not evaluate all the performance and all the parameters for every possible application. Thus the user should be in a right position to choose the suitable product for their own application. If there is any query, please contact Hongfa for the technical service. However, it is the user's responsibility to determine which product should be used only.